



# Your new POP kit for your site has arrived.

This new POP kit contains updated signage for your site with information on our latest campaign.  
**Runs on-site August 2 - October 31, 2017.**



**APPLY TODAY**



# Checklist

DISPLAY YOUR PROMOTIONAL  
ITEMS ON 8/2/2017

## ❑ OPEN YOUR PROMOTIONAL KIT AND CHECK IT CAREFULLY.

Make sure you received all the promotional elements assigned to your location as shown in the promotional placement diagram.

## ❑ DISPLAY YOUR NEW BP POP KIT BEGINNING WEDNESDAY, AUGUST 2nd, 2017.

Remove all past BP promotional elements. Refer to the promotional elements placement diagram for details.

Every employee has a chance to help make this program a success! You can also encourage employees to check out [www.mybpstation.com](http://www.mybpstation.com) for more information.

## ADDITIONAL INFORMATION ABOUT ON-SITE MATERIALS FOR THE PROMOTIONAL PROGRAM:

- If you need additional promotional elements, contact Global Business Services Americas at **888-BP-HELP-U (888-274-3578)**, option 3, then 3, then 2. Or go to [www.bpconnection.com](http://www.bpconnection.com) and select IDL Worldwide under the links section.
- The IDL website will go live with new items starting on 7/21.
- If you require additional BP Driver Rewards Program brochures, contact Global Business Services Americas at **888-BP-HELP-U (888-274-3578)**, option 3, then 3, then 2.
- If you require additional BP Credit brochures or Fleet applications, contact IDL Worldwide at **1-800-499-4824**.



EARN \$0.25



BP Credit Cards 8/2/17-10/31/17

APPLY TODAY



# Exterior POP placement diagram — all sites

DISPLAY YOUR PROMOTIONAL ITEMS ON 8/2/2017

PLEASE FOLLOW THESE SPECIAL INSTRUCTIONS.

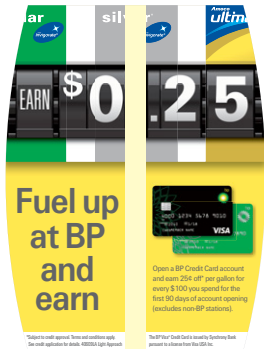

- 1 Light Approach  
40609LA  
40609NYLA



BP Credit Cards 8/2/17-10/31/17



APPLY TODAY

# Pump POP placement diagram — all sites (exceptions: NY, NJ, CT, MA, ME, NH and sites that cannot display the crind strips)

DISPLAY YOUR PROMOTIONAL ITEMS ON 8/2/2017



**1** Apollo Decal\*  
40609AD  
\*for Apollo Pumps only



**2** Apollo Approach\*  
40609AA  
\*for Apollo Pumps only

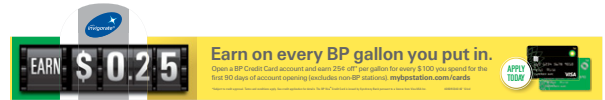

**3** Crind Strip  
40609CS27  
40609CS40

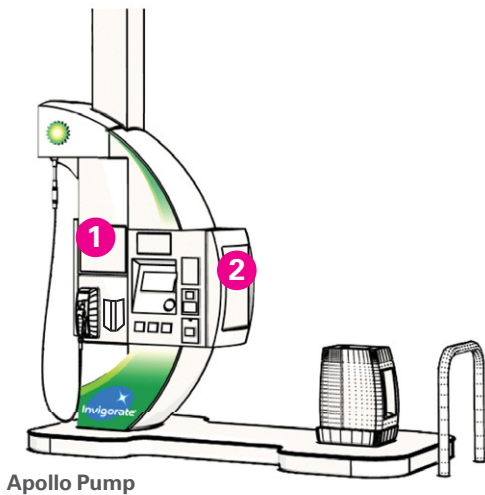

Apollo Pump

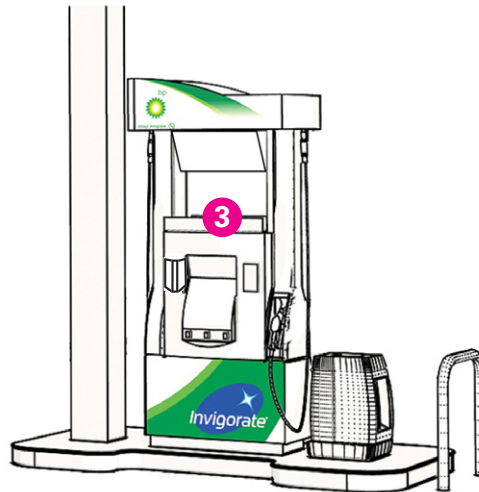

BP Credit Cards 8/2/17-10/31/17



APPLY TODAY

# POP placement-only sites that can display crind strips

DISPLAY YOUR PROMOTIONAL ITEMS ON 8/2/2017

INSERT CRIND POP. SLIDE CRIND SNAP-IN OVER CRIND POP.

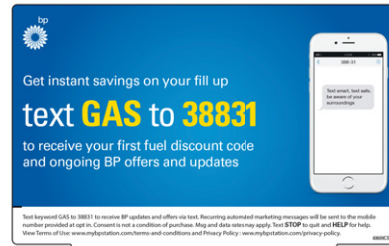
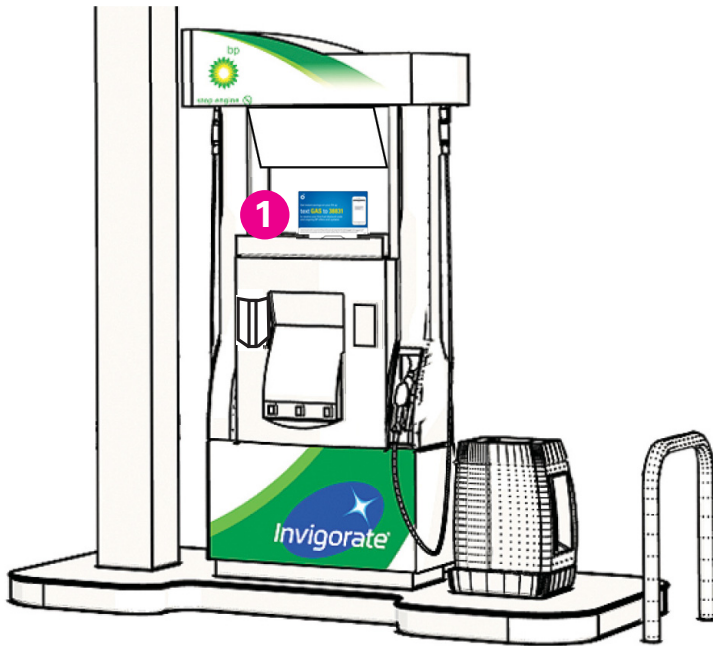

40609CSI

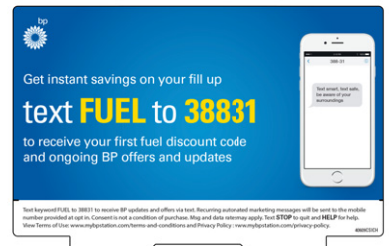

40609CSICH (Chicago-Only)

**1** Crind Snap-In



EARN \$0.25



BP Credit Cards 8/2/17-10/31/17



# Pump POP placement diagram — NY (excludes NYC), NJ, CT, MA, ME, NH and sites that cannot display the crind strips

DISPLAY YOUR PROMOTIONAL ITEMS ON 8/2/2017



**1** Apollo Decal\*  
40609AD  
\*for Apollo Pumps only



**2** Apollo Approach\*  
40609AA  
\*for Apollo Pumps only

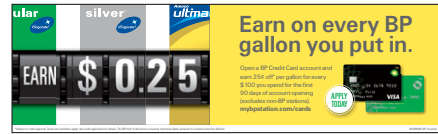

**3** Inverted Pump Sign  
40609H40  
40609OV

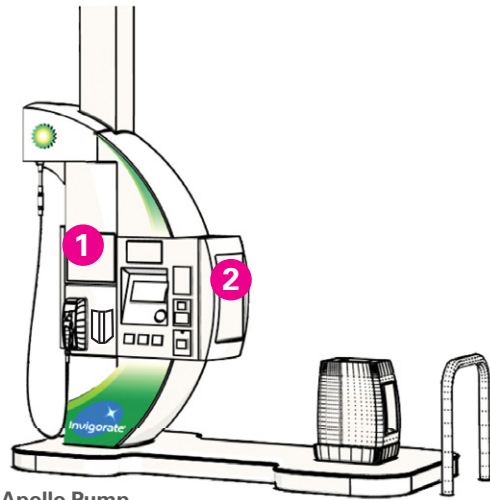

Apollo Pump

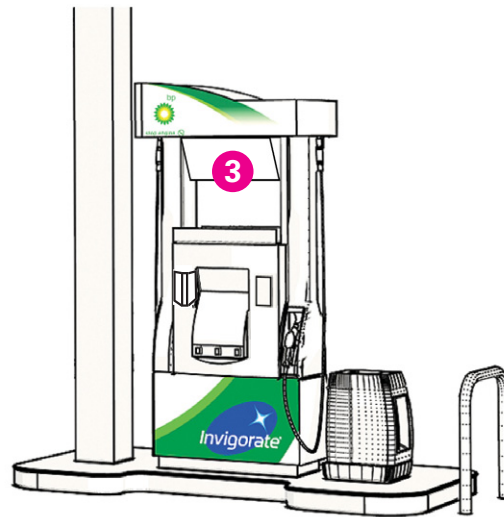

BP Credit Cards 8/2/17-10/31/17



APPLY TODAY

# Pump POP placement diagram — NYC only

DISPLAY YOUR PROMOTIONAL ITEMS ON 8/2/2017



**1** Apollo Decal\*  
40609NYAD  
*\*for Apollo Pumps only*

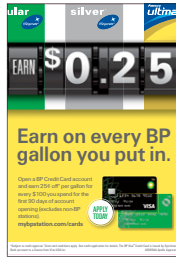

**2** Apollo Approach\*  
40609NYAA  
*\*for Apollo Pumps only*

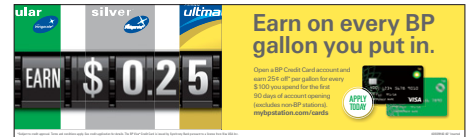

**3** Inverted Pump Sign  
40609NYH40  
40609NYOV

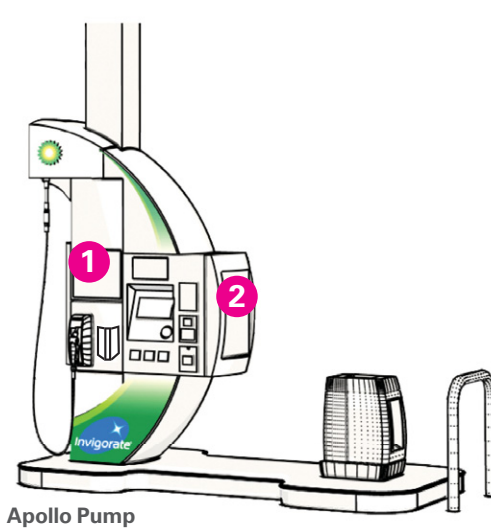

Apollo Pump

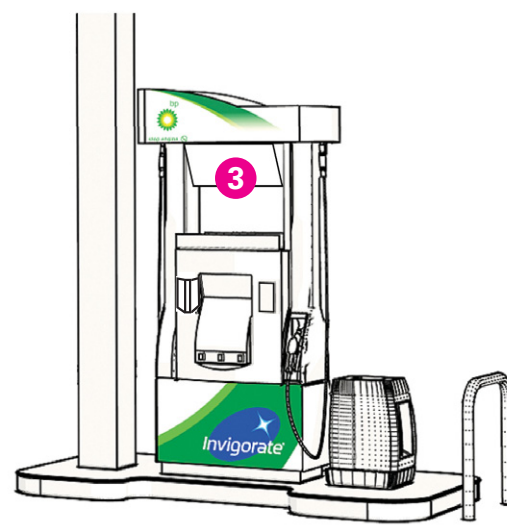

BP Credit Cards 8/2/17-10/31/17

APPLY TODAY



# Takedown sheet

DISPLAY YOUR PROMOTIONAL ITEMS ON 8/2/2017

IMPORTANT — PLEASE REMOVE ALL SIGNAGE SHOWN BELOW BY TUESDAY, AUGUST 1st, 2017.

## Exterior

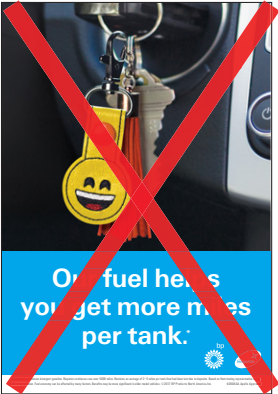

Apollo Approach



Apollo Decal



Inverted Pump Sign



Light Approach



Crind Strip



EARN \$0.25



BP Credit Cards 8/2/17-10/31/17



APPLY TODAY



# Interior POP placement diagram — all sites

DISPLAY YOUR PROMOTIONAL ITEMS ON 8/2/2017

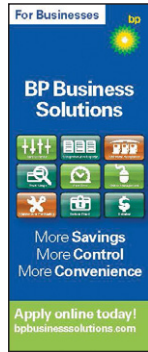
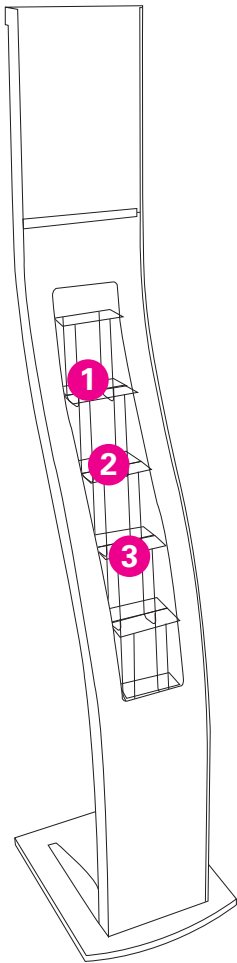

**1** Fleet Card Applications

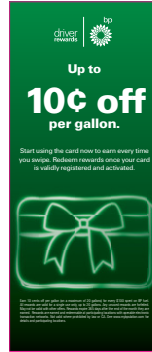

**2** BP Driver Rewards Program Brochures



**Door Decal**  
30926DECAL

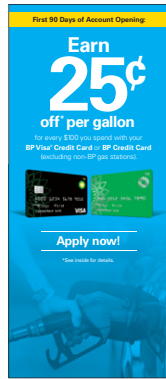

**3** BP Visa Brochures  
40797BPAPP

## Consumer/Fleet Card Display

### ADDITIONAL INFORMATION ABOUT ON-SITE MATERIALS FOR YOUR BP POP KIT:

- If you need additional POP, contact Global Business Services Americas at 888-BP-HELP-U (888-274-3578), option 3, then 3, then 2. Or go to [www.bpconnection.com](http://www.bpconnection.com) and select IDL Worldwide under the links section.
- If you require additional BP Driver Rewards Program brochures, contact Global Business Services Americas at 888-BP-HELP-U (888-274-3578), option 3, then 3, then 2.
- If you require additional BP Credit brochures or Fleet applications, contact IDL Worldwide at 1-800-499-4824.
- Keep your BP Driver Rewards Program and BP Credit brochures displayed in your stores and in the canisters at each pump (see diagrams).



BP Credit Cards 8/2/17-10/31/17



DISPLAY YOUR PROMOTIONAL ITEMS ON 8/2/2017

# Keep Up Sheet:

IMPORTANT — APPLIES ONLY TO SITES THAT RECEIVED THESE MATERIALS.

## Exterior

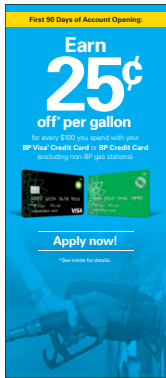

**1** BP Visa Brochures  
40797BPAPP

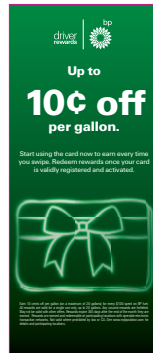

**2** BP Driver Rewards Program Brochures



Curb Display Graphic Insert

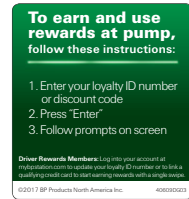
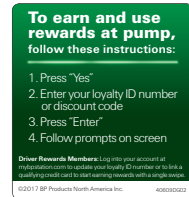
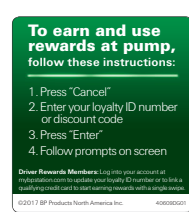

**3** Dispenser Graphic  
Install near dispenser payment area. Replace any current pieces on dispenser with new graphics from kit.\*  
40609DG01 (Gilbarco/Verifone)  
40609DG02 (Wayne)  
40609DG03 (Retalix)  
\*CSR training guide included

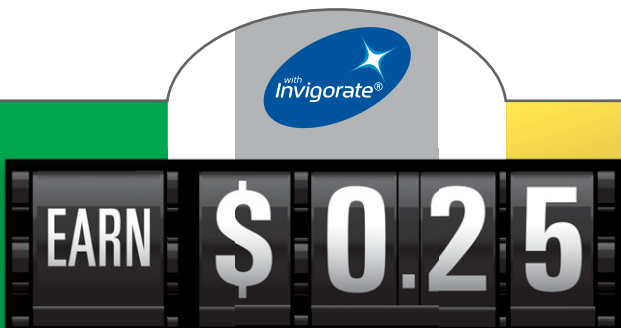
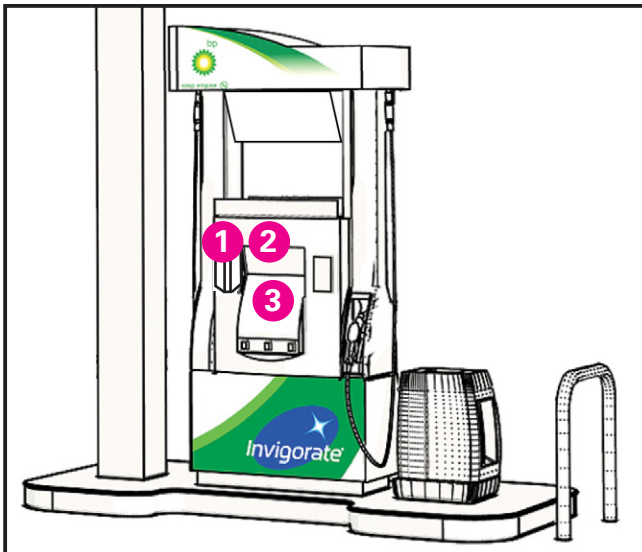

BP Credit Cards 8/2/17-10/31/17



APPLY TODAY

DISPLAY YOUR PROMOTIONAL ITEMS ON 8/2/2017

# Keep Up Sheet:

IMPORTANT — APPLIES ONLY TO SITES THAT RECEIVED THESE MATERIALS.

## Interior

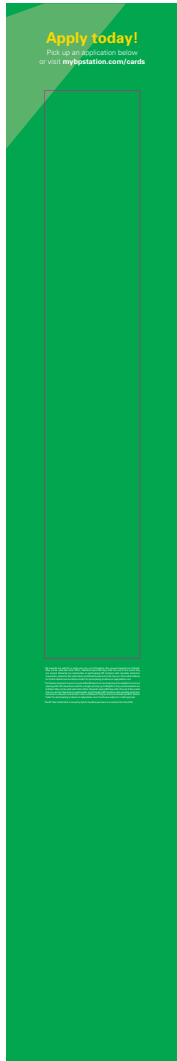

S-Channel Bottom Card

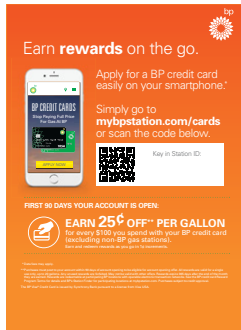

Tent Card



Window Cling



Tear Pad



Tear Pad Display



S-Channel Top Card



Tri-Fold Dangler

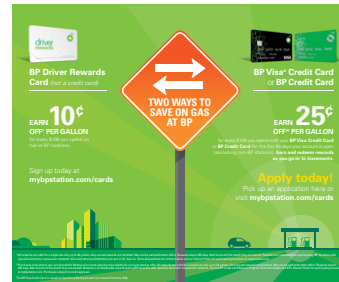

Counter Mat



Aisle Violator\*  
*\*Optional element, call the GBS to order*



BP Credit Cards 8/2/17-10/31/17

