



Your new POP kit for the BP Credit Card Promotion has arrived.

This new POP kit contains updated signage for your site with information on our latest campaign.
Runs on-site December 7th, 2016 through January 31st, 2017.



APPLY TODAY



Checklist

DISPLAY YOUR PROMOTIONAL
ITEMS ON 12/7/2016

- OPEN YOUR PROMOTIONAL KIT AND CHECK IT CAREFULLY.**
Make sure you received all the promotional elements assigned to your location as shown in the promotional placement diagram.
- DISPLAY NEW BP CREDIT CARD PROMOTIONAL KIT BEGINNING WEDNESDAY, DECEMBER 7th, 2016.**
Remove all past BP promotional elements. Refer to the promotional elements placement diagram for details.

Every employee has a chance to help make this program a success! You can also encourage employees to check out www.mybpstation.com for more information.

ADDITIONAL INFORMATION ABOUT ON-SITE MATERIALS FOR THE BP CREDIT CARD PROMOTIONAL PROGRAM:

- If you need additional promotional elements, contact Global Business Services Americas at **888-BP-HELP-U (888-274-3578)**, option 3, then 3, then 2. Or go to www.bpconnection.com and select IDL Worldwide under the links section.
- The IDL website will go live with new items starting on 11/25.
- If you require additional BP Driver Rewards Program brochures, contact Global Business Services Americas at **888-BP-HELP-U (888-274-3578)**, option 3, then 3, then 2.
- If you require additional BP Visa brochures or Fleet applications, contact IDL Worldwide at **1-800-499-4824**.



BP CREDIT CARD PROMOTION 12/7/16–1/31/17

APPLY
TODAY



Exterior POP placement diagram — all sites

DISPLAY YOUR PROMOTIONAL ITEMS ON 12/7/2016

PLEASE FOLLOW THESE SPECIAL INSTRUCTIONS.

This POP kit contains a limited number of elements.
(Please turn to the Keep Up Sheet on page 9 for notice on Exterior launch items.)



1 Light Approach
30926LA
30926NYLA



BP CREDIT CARD PROMOTION 12/7/16–1/31/17



Pump POP placement diagram — all sites (exceptions: NY, NJ, CT, MA, ME, NH and sites that cannot display the crind strips)

DISPLAY YOUR PROMOTIONAL ITEMS ON 12/7/2016

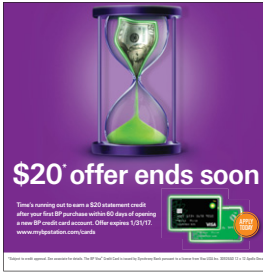

1 Apollo Decal*
30926AD
*for Apollo Pumps only



2 Apollo Approach*
30926AA
*for Apollo Pumps only



3 Crind Strip
30926CS27
30926CS40

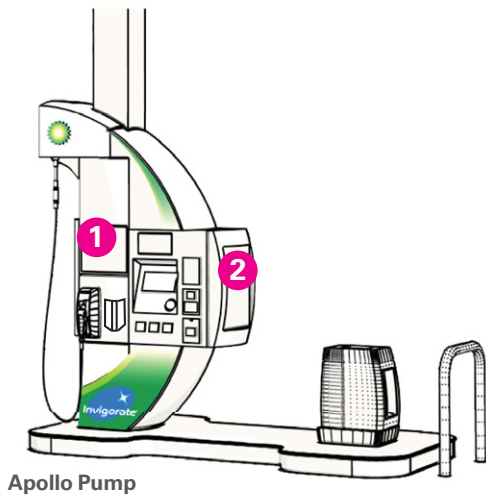

Apollo Pump

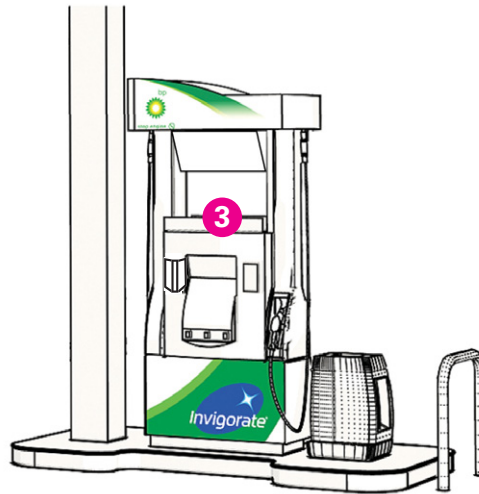

BP CREDIT CARD PROMOTION 12/7/16–1/31/17



Pump POP placement diagram — NY (excludes NYC), NJ, CT, MA, ME, NH and sites that cannot display the crind strips

DISPLAY YOUR PROMOTIONAL ITEMS ON 12/7/2016

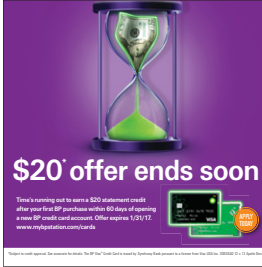

1 Apollo Decal*
30926AD
*for Apollo Pumps only



2 Apollo Approach*
30926AA
*for Apollo Pumps only

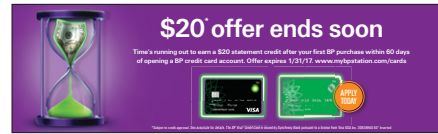

3 Inverted Pump Sign
30926H40
30926OV

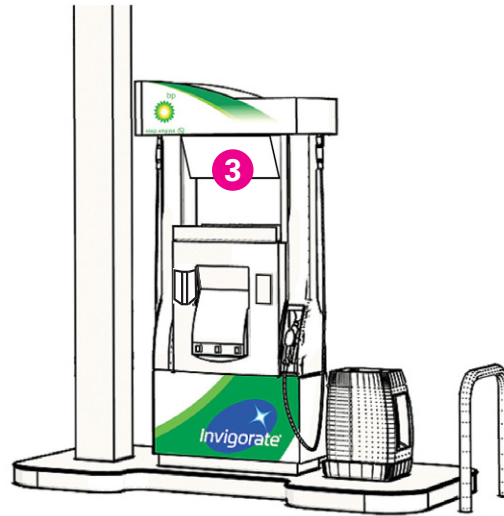
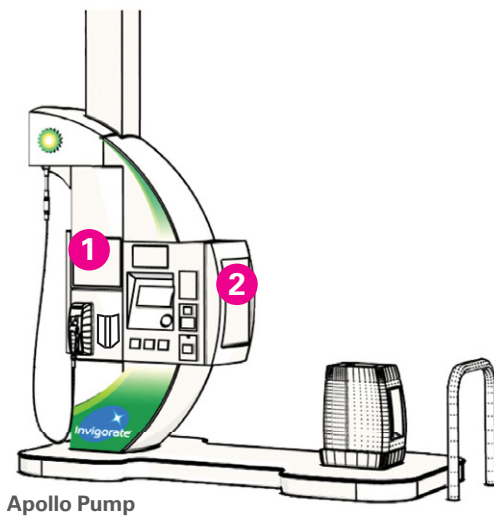

BP CREDIT CARD PROMOTION 12/7/16-1/31/17



Pump POP placement diagram — NYC only

DISPLAY YOUR PROMOTIONAL ITEMS ON 12/7/2016

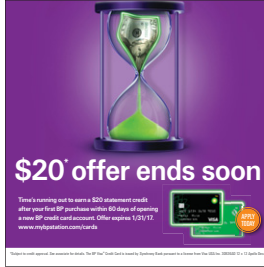

1 Apollo Decal*
30926NYAD
*for Apollo Pumps only



2 Apollo Approach*
30926NYAA
*for Apollo Pumps only



3 Inverted Pump Sign
30926NYH40
30926NYOV

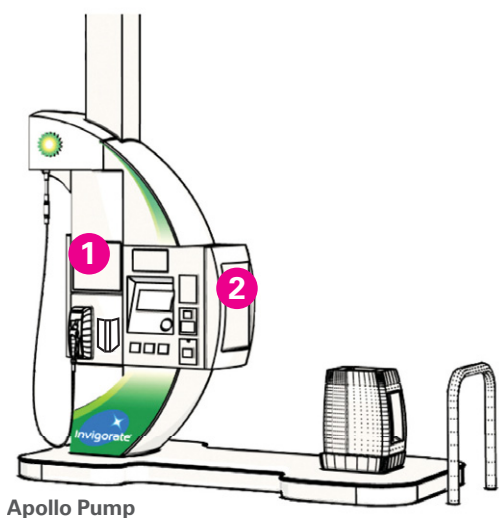

Apollo Pump

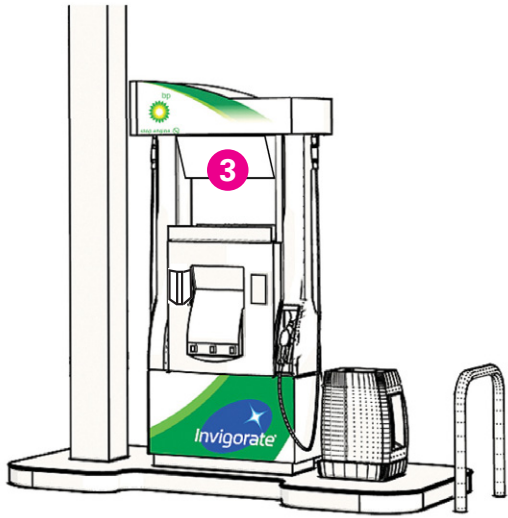

BP CREDIT CARD PROMOTION 12/7/16-1/31/17



Interior POP placement diagram — all sites

DISPLAY YOUR PROMOTIONAL ITEMS ON 12/7/2016

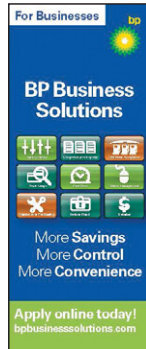
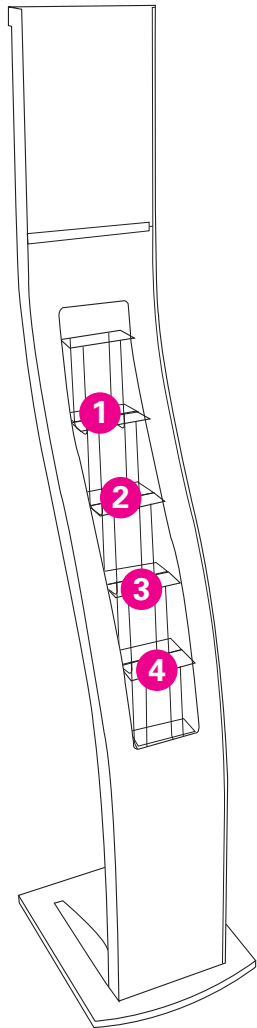

1 Fleet Card Applications
30619BPAPP-500

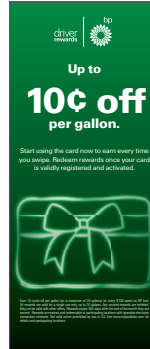

2 BP Driver Rewards Program Brochures
35341BKSLP



Door Decal
30926DECAL

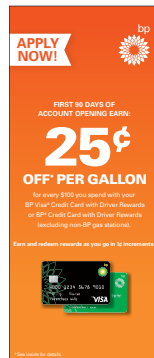

3 BP Credit Card Brochure*
30619BPAPP-500



4 BP Buck Slip
35341BKSLP

Consumer/Fleet Card Display

ADDITIONAL INFORMATION ABOUT ON-SITE MATERIALS FOR THE BP CREDIT CARD PROMOTIONAL PROGRAM:

- If you need additional POP, contact Global Business Services Americas at 888-BP-HELP-U (888-274-3578), option 3, then 3, then 2. Or go to www.bpconnection.com and select IDL Worldwide under the links section.
- If you require additional BP Driver Rewards Program brochures, contact Global Business Services Americas at 888-BP-HELP-U (888-274-3578), option 3, then 3, then 2.
- If you require additional BP Visa brochures or Fleet applications contact, IDL Worldwide at 1-800-499-4824.
- Keep your BP Driver Rewards Program and BP Credit Card brochures displayed in your stores and in the canisters at each pump (see diagrams).



BP CREDIT CARD PROMOTION 12/7/16–1/31/17

APPLY TODAY



Takedown sheet

DISPLAY YOUR PROMOTIONAL ITEMS ON 12/7/2016

IMPORTANT — PLEASE REMOVE ALL SIGNAGE SHOWN BELOW BY DECEMBER 6th, 2016.

Exterior

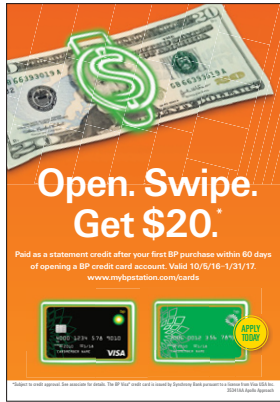

Apollo Approach

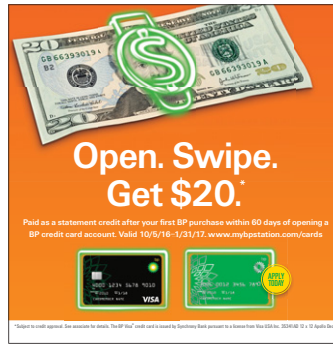

Apollo Decal

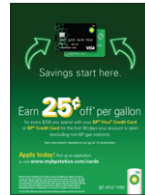

Window Cling



Light Approach

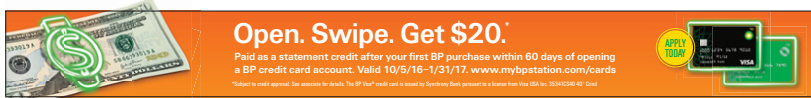

Crind Strip

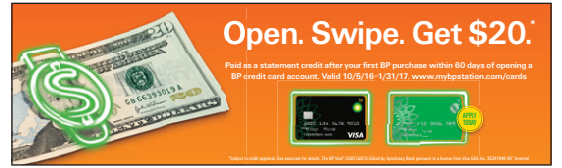

Inverted Pump Sign

Interior



BP Countertop Brochure Holder



Bottom Card

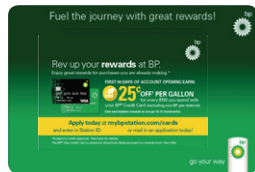

Tear Pad Engagement Holder

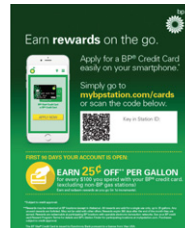

Tent Card



Tri-Fold Dangler



BP CREDIT CARD PROMOTION 12/7/16-1/31/17



Keep Up Sheet: Materials you received from P4, P7 and P10 POP

DISPLAY YOUR PROMOTIONAL ITEMS ON 12/7/2016

IMPORTANT — APPLIES ONLY TO SITES THAT RECEIVED THESE MATERIALS.

Exterior



1 Teardrop
34725TRDROP-2

2 Curb Display Graphic Insert*
35341CDG
35341NYCDG
**Applies to sites that receive the Curb Display only.*

3 BP Driver Rewards Program Brochures

4 BP Credit Card Brochure*
30619BPAPP-500

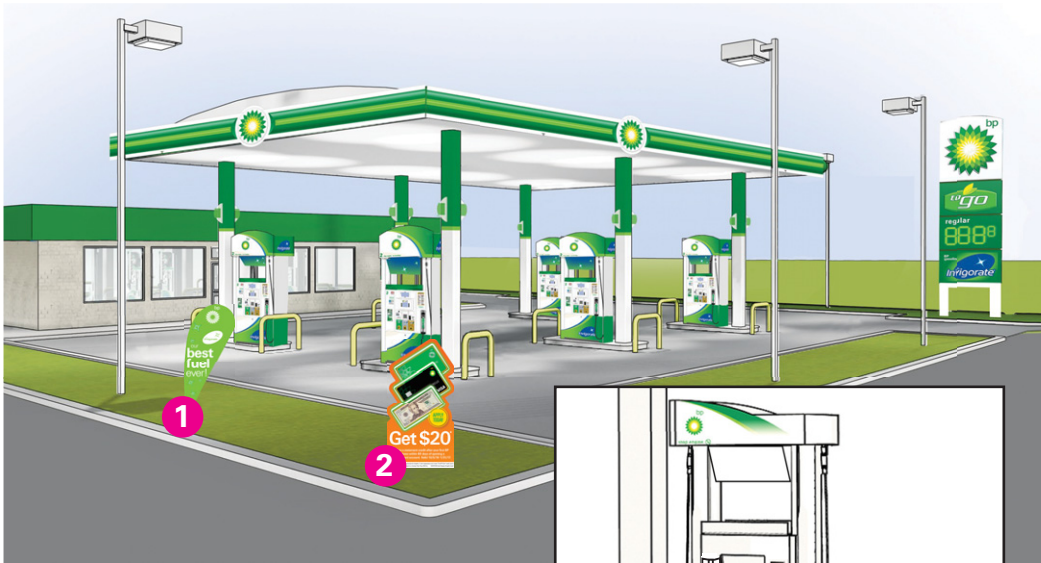

Interior

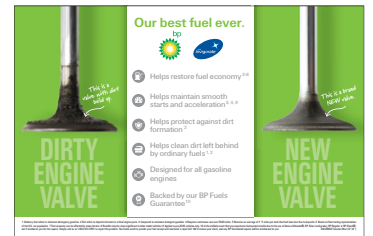

Counter Mat
34820MAT
34820NYMAT

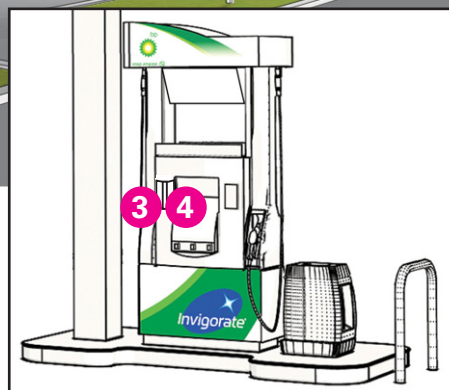

BP CREDIT CARD PROMOTION 12/7/16-1/31/17



DISPLAY YOUR PROMOTIONAL ITEMS ON 12/7/2016

New Interior POP for BP Credit Cards

Apply today!
Pick up an application below or visit mybpstation.com/cards

S-Channel Bottom Card

Earn rewards on the go.

Apply for a BP credit card easily on your smartphone.

Simply go to mybpstation.com/cards or scan the code below.

Key in Station ID:

FIRST 90 DAYS YOUR ACCOUNT IS OPEN:

EARN 25¢ OFF PER GALLON** for every gallon you spend with your BP credit card (see restrictions below at gas stations).

Tent Card

STOP
PAYING FULL PRICE FOR GAS AT BP

Apply today! Pick up an application at mybpstation.com/cards

Window cling

EARN 25¢ OFF PER GALLON**

Apply today! Pick up an application at mybpstation.com/cards or mail in an application today!

Tear Pad

Stop paying full price for gas at BP!

Tear Pad Display

This way to save on gas at BP!

Whether it's our loyalty program or credit card, now you can choose the route that's perfect for you.

EARN 25¢ OFF PER GALLON**

With a BP Visa® Credit Card or BP Credit Card for every gallon you spend with your BP credit card (see restrictions below at gas stations).

After 90 days, for every \$500 you spend:

- BP Visa® Credit Card: Earn 15¢ off per gallon on gas purchases.
- BP Credit Card: Earn 15¢ off per gallon on gas purchases.
- BP Driver Rewards Card: Earn 10¢ off per gallon on gas purchases.

BP Driver Rewards Card (see restrictions below at gas stations).

EARN 10¢ OFF PER GALLON** for every gallon you spend at BP.

S-Channel Top Card

STOP
PAYING FULL PRICE FOR GAS AT BP

With a BP Visa® Credit Card or BP Credit Card

Apply today!
Pick up an application at mybpstation.com/cards

Tri-fold Dangler

BP Driver Rewards Card (see restrictions below at gas stations)

EARN 10¢ OFF PER GALLON** for every gallon you spend at BP.

Sign up today at mybpstation.com/cards

TWO WAYS TO SAVE ON GAS AT BP

BP Visa® Credit Card or **BP Credit Card**

EARN 25¢ OFF PER GALLON** for every gallon you spend with your BP credit card (see restrictions below at gas stations).

Apply today!
Pick up an application here or visit mybpstation.com/cards

Counter Mat

Buy in here.

Save out there.

Earn rewards* on store purchases. Redeem rewards at the pump!

Apply today!

Aisle Violator*
*Optional element-contact IDL for purchase



BP CREDIT CARD PROMOTION 12/7/16-1/31/17

